

2A SINK & SOURCE ADJUSTABLE LINEAR REGULATOR

GENERAL DESCRIPTION

The CM8562 is a low cost linear regulator designed to provide a desired output voltage or termination voltage for various applications by converting voltage supplies ranging from 1V to 6.0V. The desired output voltage could be programmable by two external voltage divider resistors.

The CM8562 is capable of sourcing or sinking up to 2A of current while regulating an output VOUT voltage to within 2%(DDR-I) , 3% (DDR-II) or less .

The CM8562 provides low profile 8-pin SOIC package to save system space.

FEATURES

- ◆ Ideal for DDR-I 、DDR-II and DDR-III
- ◆ 8-pin SOIC w/ power pad package, 5-Lead SOT-252 package
- ◆ 2 ways to adjust the output, VOUT with VFB pin
- ◆ Source and sink up to 2A , no heat sink required
- ◆ Integrated power MOSFETs
- ◆ Programmable output voltage by external resistors
- ◆ Output voltage could go down to 0.6V
- ◆ Iccq at VCCA less than 500uA
- ◆ Current limit protection and Short Circuit protection
- ◆ Thermal shutdown protection
- ◆ Shutdown for standby or suspend mode operation
- ◆ Minimum external components

APPLICATIONS

- ◆ Mother Board
- ◆ PCI/AGP Graphics
- ◆ Game/ Play Station
- ◆ Set Top Box
- ◆ IPC
- ◆ SCSI-III Bus terminator

PIN CONFIGURATION

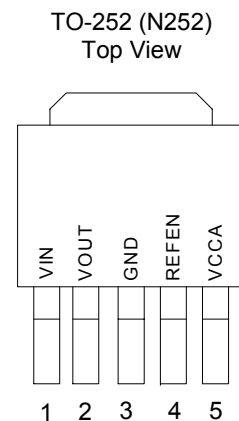
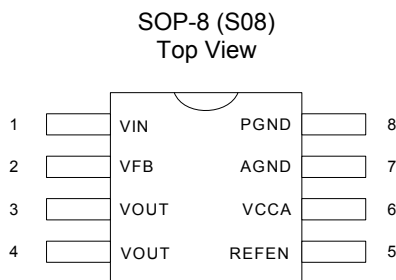

PIN DESCRIPTION

Pin No.		Symbol	Description	Operating Rating			
5-Lead	8-Pin			Min.	Typ.	Max.	Unit
1	1	VIN	Input Power	1	2.5/1.8/1.5	6	V
	2	VFB	Feedback node for the V _{OUT}			6	V
2	3,4	VOUT	Output Voltage			6	V
4	5	REFEN	Reference Voltage Input and Chip Enable			VCCA-1.9	V
5	6	VCCA	Voltage supply for internal circuits			6	V
3	7	AGND	Analog Ground				
	8	PGND	Power Ground				

ORDERING INFORMATION

Part Number	Temperature Range	Package
CM8562IS	-40°C to 85°C	8-Pin SOP (S08)
CM8562IN252	-40°C to 85°C	5-Lead TO-252 (N252)
CM8562GIS*	-40°C to 85°C	8-Pin SOP (S08)
CM8562GIN252*	-40°C to 85°C	5-Lead TO-252 (N252)

*Note : G : Suffix for Pb Free Product

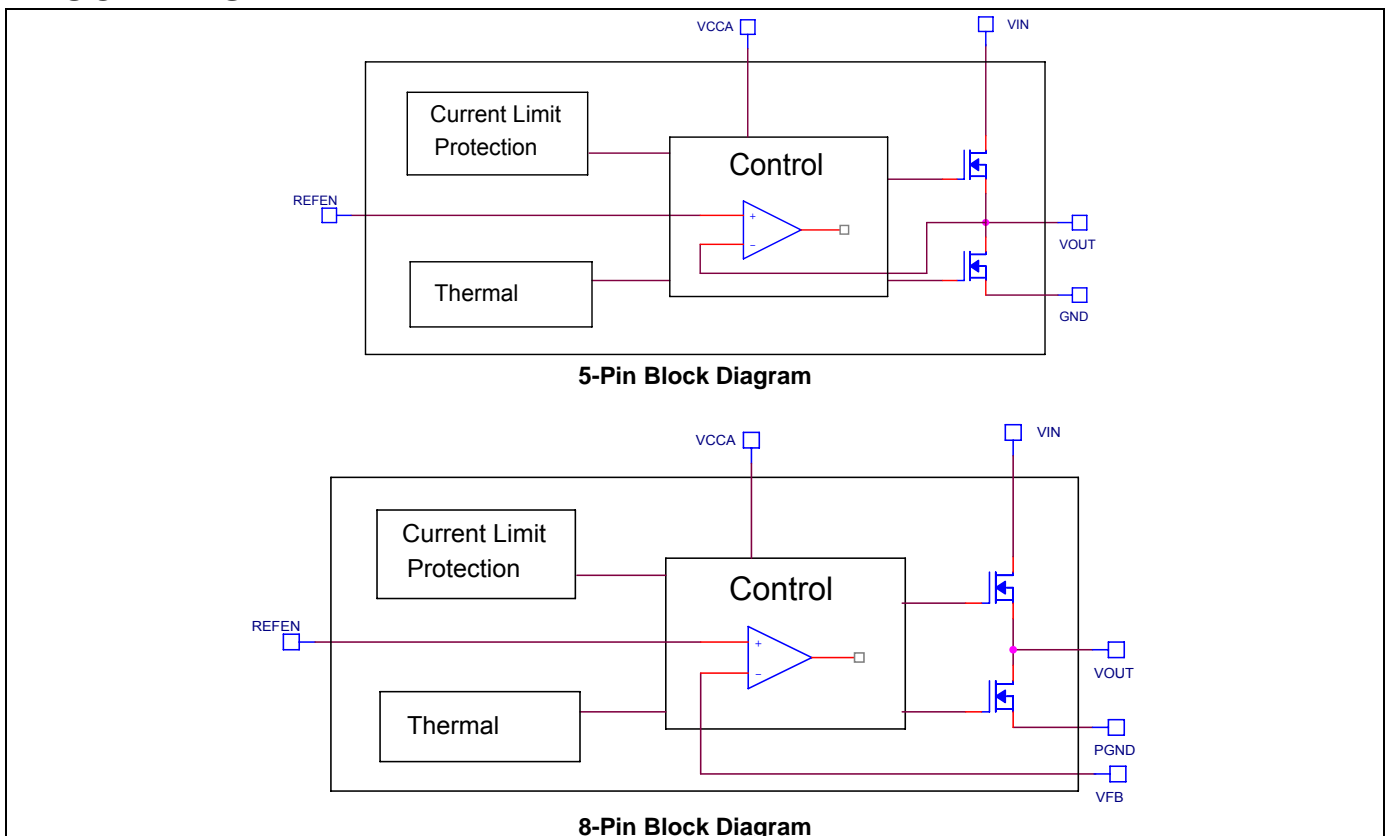
BLOCK DIAGRAM

APPLICATION CIRCUITS

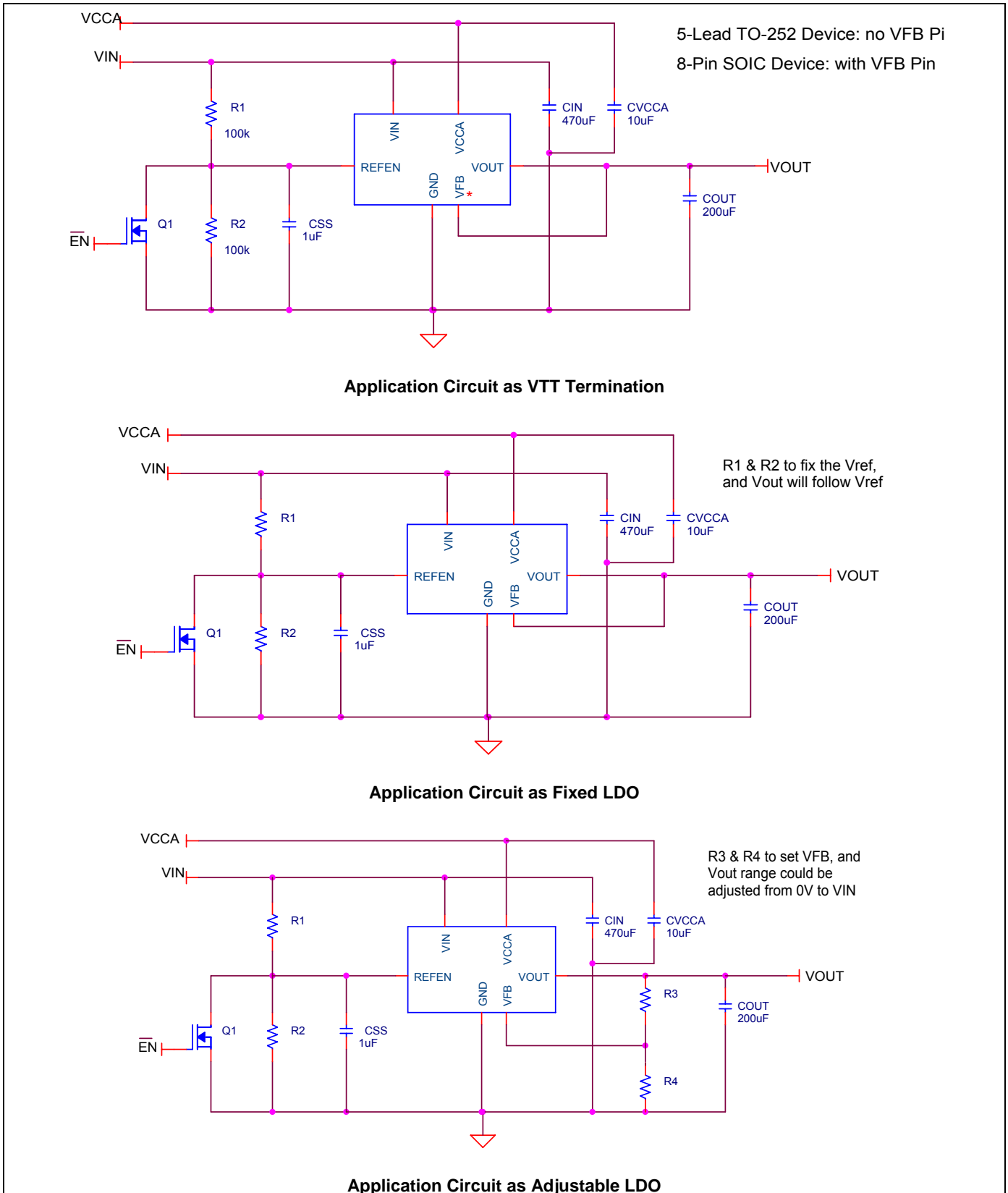

2A SINK & SOURCE ADJUSTABLE LINEAR REGULATOR
ABSOLUTE MAXIMUM RATINGS

Absolute maximum ratings are those values beyond which the device could be permanently damaged.

VIN, VCCA, VFB	7V	Lead Temperature (Soldering, 5 sec).....	260°C
Output RMS Current, Source or Sink	2A	Thermal Resistance(θ_{JC}).....	14°C/W (PSOP-8)
Storage Temperature	-65°C to 125°C	Thermal Resistance(θ_{JC}).....	8°C/W (TO-252)
		Thermal Resistance(θ_{JA}).....	75°C/W

ELECTRICAL CHARACTERISTICS (Unless otherwise stated, these specifications apply $T_A=25^\circ\text{C}$; $V_{IN}=+2.5\text{V}$ and $V_{CCA}=+3.3\text{V}$, $V_{REFEN}=1.25\text{V}$) maximum ratings are stress ratings only and functional device operation is not implied. (Note 1)

Symbol	Parameter	Test Conditions	CM8562			Unit
			Min.	Typ.	Max.	
V_{OS}	Output Offset Voltage	$I_{OUT}=0\text{A}$ (Note 2)	-20		20	mV
I_{OP}	Operating Current at VIN	No load, $C_{out}=200\mu\text{F}$			1	mA
$ \Delta V_{LOAD} $	Load Regulation (DDR I/II)	$I_L: 0\text{A} \rightarrow 2\text{A}$		0.8/1.2	2/3	%
		$I_L: 0\text{A} \rightarrow -2\text{A}$		0.8/1.2	2/3	%
$V_{DROPOUT}$	Dropout Voltage	$V_{CCA}>V_{OUT}+1.9\text{V}$ $I_{out}=2\text{A}$		0.3	0.4	V
		$V_{CCA}>V_{OUT}+1.9\text{V}$ $I_{out}=1.5\text{A}$		0.2	0.25	V
I_{CCQ}	Quiescent Current at V_{CCA}	At Room Temp.		190	230	μA
I_{SHDN}	Current in Shutdown Mode	$REFEN<0.2\text{V}$, $R_L = 10\text{ Ohm}$		90	110	μA
V_{IN}	Input Voltage Range (Note 3)	No Load	1	2.5/1.8	6	V
V_{CCA}	Input Voltage Range (Note 3)	$R_L = 10\text{ Ohm}$	3.15	3.3	6	V
SHORT CIRCUIT PROTECTION						
I_{LIMIT}	Current Limit			5		A
$I_{SC,VIN}$	Short Current	Sinking	2			A
$I_{SC,GND}$	Short Current	Sourcing	2			A
OVER THERMAL PROTECTION						
THSD	Thermal Shutdown Temperature	$3.15\text{V} \leq V_{CCA} \leq 6\text{V}$	125	150	155	$^\circ\text{C}$
	Thermal Shutdown Hysteresis		25	30	35	$^\circ\text{C}$
REFEN FUNCTION						
	REFEN Threshold	$V_{REFEN} < V_{IN}$ $V_{REFEN} < V_{CCA} - 1.9\text{V}$	0.4	0.5	0.6	V

Note 1: Limits are guaranteed by 100% testing, sampling, or correlation with worst case test conditions

Note 2: $V_{OS} = V_{REFEN} - V_{OUT}$

Note 3: Keep $V_{CCA} \geq V_{IN}$ and $V_{CCA} \geq V_{REFEN} + 1.9\text{V}$ on operation power on and power off sequences

Note 4: Guaranteed by design, not 100% test

FUNCTIONAL DESCRIPTION

The CM8562 is a linear regulator that is capable of sinking and sourcing 2A of current without an external heat sink.

The CM8562 integrates power MOSFETs that are capable of source and sink 2A of current while maintaining excellent voltage regulation. The output voltage can be regulated within 3% or less by using the external feedback. Separate voltage supply inputs have been added to fit applications with various power supplies for the databus and power buses.

OUTPUTS

The output voltage pins (VOUT) are tied to the databus, address, or clock lines via an external inductor. Output voltage is determined by the VIN.

INPUTS

The input voltage pins (VIN) determine the output voltages (VOUT). At CM8562, the desired output voltage could be programmable by two external voltage divider resistors. VIN is suggested to connect to VDDQ of memory module for better tracking with memory VDDQ.

OTHER SUPPLY VOLTAGES

VCCA provide the voltage supply to the logic section and internal error amplifiers of CM8562.

DIFFERENT HEATSINK AREA

Thermal Resistance vs. Different Cooper Area Layout Design

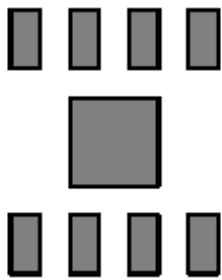
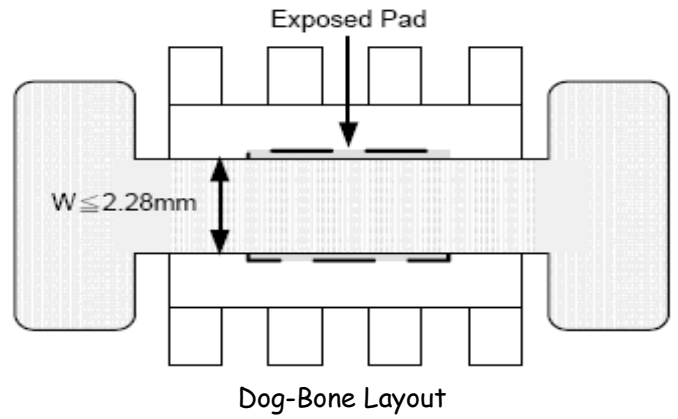
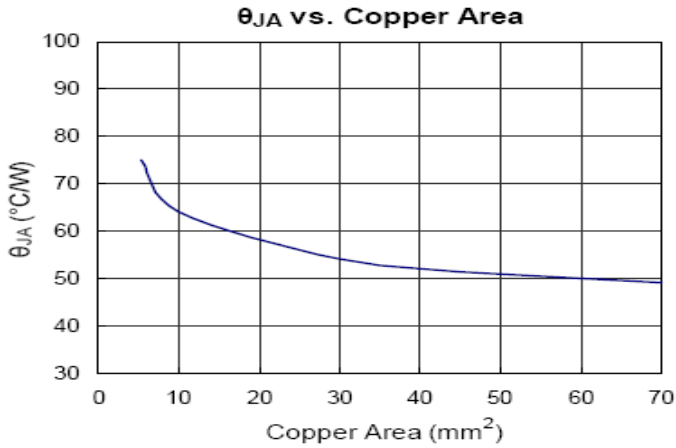

Minimum Footprint , $\theta_{JA} = 75^{\circ}\text{C}/\text{W}$

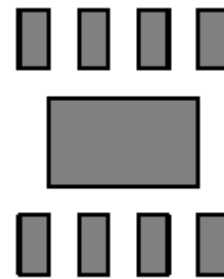

Copper Area = 10mm^2 , $\theta_{JA} = 64^{\circ}\text{C}/\text{W}$

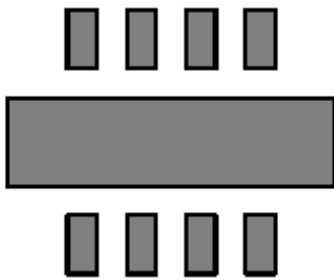

Copper Area = 30mm^2 , $\theta_{JA} = 54^{\circ}\text{C}/\text{W}$

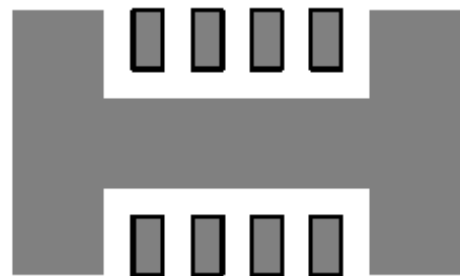

Copper Area = 50mm^2 , $\theta_{JA} = 51^{\circ}\text{C}/\text{W}$

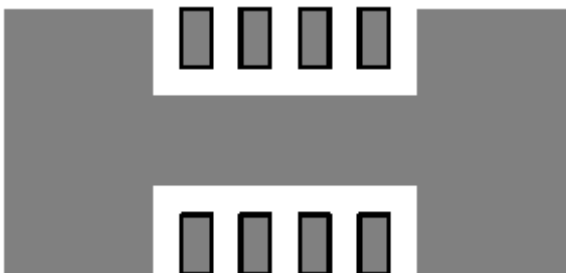

Copper Area = 70mm^2 , $\theta_{JA} = 49^{\circ}\text{C}/\text{W}$

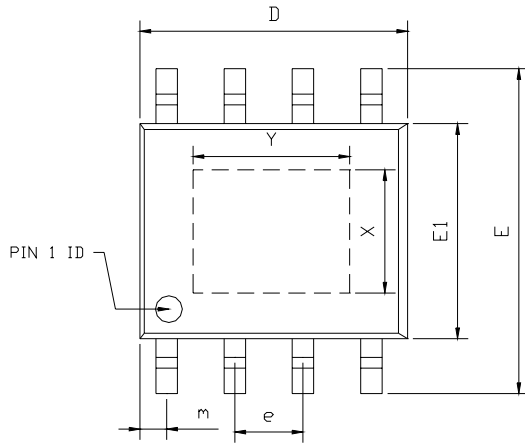
PACKAGE DIMENSION
8-Pin SOP w/ Power Pad (PS08)

SYMBOLS	DIMENSIONS IN MILLIMETERS			DIMENSIONS IN INCHS		
	MIN	NOM	MAX	MIN	NOM	MAX
A1	0.10	---	0.25	0.004	---	0.010
A2	1.40	---	1.55	0.055	---	0.061
b	0.30	---	0.51	0.012	---	0.020
C	0.15	---	0.28	0.006	---	0.010
D	4.60	---	5.06	0.169	---	0.199
E	5.79	---	6.20	0.228	---	0.244
E1	3.76	---	4.01	0.148	---	0.158
e	---	1.27	---	---	0.050	---
L	0.38	---	0.69	0.015	---	0.035
m	0.43	---	0.69	0.017	---	0.027
θ	0°	---	8°	0°	---	8°

EXPOSED PAD DIMENSION : (mm)
PAD SIZE: X=2.34 ; Y=2.92

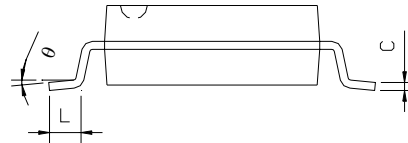
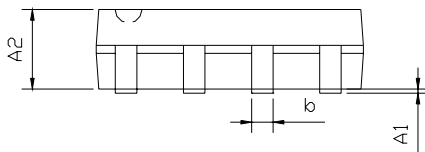
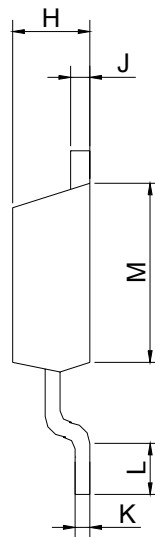
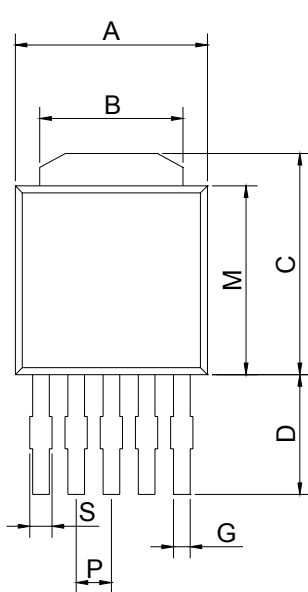
5-Lead TO-252 (N252)

Front View

Side View

SYMBOLS	DIMENSIONS IN MILLIMETERS			DIMENSIONS IN INCHS		
	MIN	NOM	MAX	MIN	NOM	MAX
A	6.40	---	6.80	0.252	---	0.268
B	5.20	---	5.50	0.205	---	0.217
C	6.80	---	7.20	0.268	---	0.283
D	2.20	---	2.60	0.087	---	0.110
G	0.40	---	0.60	0.016	---	0.024
P	1.27REF			0.05REF		
H	2.20	---	2.40	0.087	---	0.094
J	0.45	---	0.55	0.018	---	0.022
K	0.05	---	0.15	0.002	---	0.006
L	0.90	---	1.50	0.035	---	0.059
M	5.40	---	5.80	0.212	---	0.228
S	0.50	---	0.80	0.019	---	0.031

IMPORTANT NOTICE

Champion Microelectronic Corporation (CMC) reserves the right to make changes to its products or to discontinue any integrated circuit product or service without notice, and advises its customers to obtain the latest version of relevant information to verify, before placing orders, that the information being relied on is current.

A few applications using integrated circuit products may involve potential risks of death, personal injury, or severe property or environmental damage. CMC integrated circuit products are not designed, intended, authorized, or warranted to be suitable for use in life-support applications, devices or systems or other critical applications. Use of CMC products in such applications is understood to be fully at the risk of the customer. In order to minimize risks associated with the customer's applications, the customer should provide adequate design and operating safeguards.

HsinChu Headquarter

5F, No. 11, Park Avenue II,
Science-Based Industrial Park,
HsinChu City, Taiwan 300

TEL: +886-3-567 9979

FAX: +886-3-567 9909

<http://www.champion-micro.com>

Sales & Marketing

7F-6, No.32, Sec. 1, Chenggong Rd.,
Nangang District, Taipei City 115, Taiwan

TEL: +886-2-2788 0558

FAX: +886-2-2788 2985